

# Kubus KBX 104 45 Drainer Specifications

- Useful individual bowl
- 45mm waste/overflow
- Attractive 25mm radius
- Hygienic
- Easy to clean
- Minimalist design
- Compatible with Kubus models

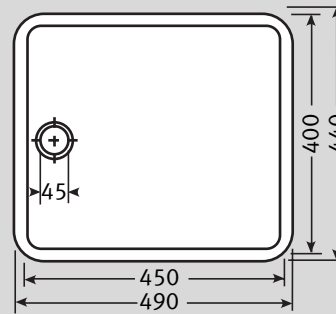

<b>Material:</b>	Stainless Steel
<b>Application:</b>	Undermount
<b>Bowl size:</b>	N/A
<b>Drainer Format:</b>	450 X 400 X 25
<b>Cut-out size:</b>	Utilise Template
<b>Colour:</b>	Silk Stainless Steel
<b>Seal:</b>	N/A
<b>Insulation:</b>	Black Pads for sound insulation
<b>Heat Resistance:</b>	Up to 300°C
<b>Earthing Point:</b>	N/A

**Waste:** 1 x Lira 45mm Basket Strainer Waste

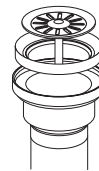

**Accessories available:**

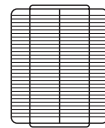

**Drainer Grille**  
Stainless Steel

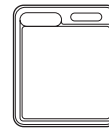

**Chopping Board**  
Wood/Iroko

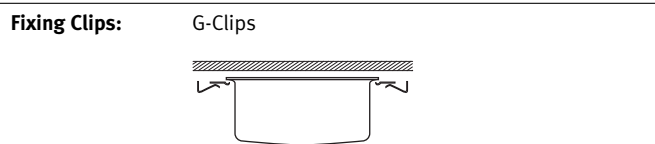
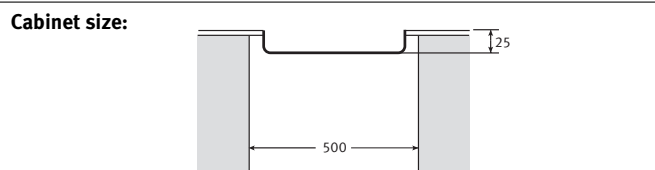

**Suggested Plumbing Kit:** 1 part or combination

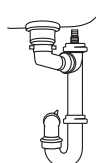

**Taps:** Any Franke tap can be utilised with this model\*.

\*Ceramic disc taps in certain installations or where there is a low head of water (below 4 meters) may not provide adequate flow rates. You are advised to check with your supplier.

Some taps may need bracing to avoid flexing of the sink ledge.

**Guarantee:** Franke sinks are guaranteed for 25 years against manufacturing defect. Franke taps are guaranteed against defective materials and workmanship for 1 year in relation to coatings and finishes, and 5 years in relation to moving parts. Franke will replace (and where appropriate repair) defective sinks. In relation to taps, Franke will where appropriate provide replacement parts for your taps or replace your taps. Any associated or ancillary costs to be incurred by you as a result of replacement of Franke sinks and taps under this guarantee shall in all cases be previously approved by Franke UK Limited. This guarantee is in addition to and does not affect your statutory rights.