

Kubus KBX 110 45 Specifications

- Useful individual bowl
- Semi-Integrated 90mm Waste at rear of bowl
- Attractive 25mm radius
- Hygienic flat overflow
- Easy to clean
- Minimalist design
- Compatible with Kubus models/taps
- Capable of adaption to Waste Disposals Unit

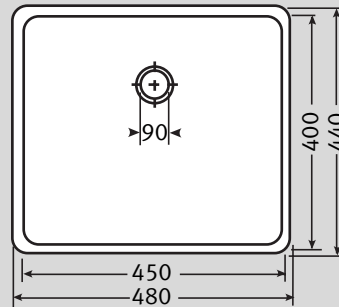

Material:	Stainless Steel
Application:	Undermount
Bowl size:	450 x 400 x 180
Drainer Format:	N/A
Cut-out size:	Utilise Template
Colour:	Silk Stainless Steel
Seal:	N/A
Insulation:	Black Pads for sound insulation
Heat Resistance:	Up to 300°C
Earthing Point:	N/A

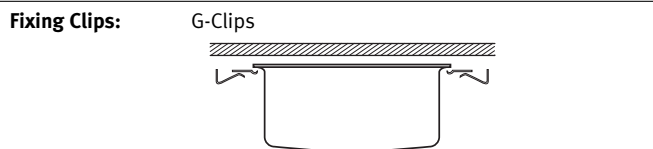
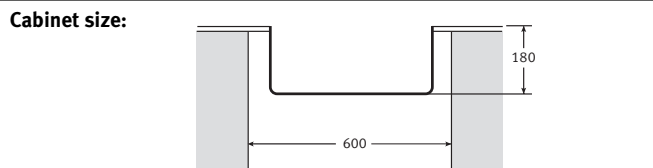

Suggested Plumbing Kit: 1 part or combination

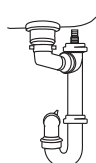

Waste: 1 x Lira 90mm Semi-Integrated Basket Strainer Waste with overflow

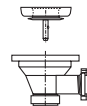

Overflow:

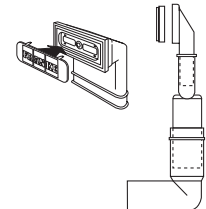

Accessories available:

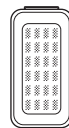

Strainer Bowl with handles
Stainless Steel



Drainer Grille
Stainless Steel

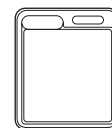

Chopping Board
Wood/Iroko

Taps: Any Franke tap can be utilised with this model*.

*Ceramic disc taps in certain installations or where there is a low head of water (below 4 meters) may not provide adequate flow rates. You are advised to check with your supplier.

Some taps may need bracing to avoid flexing of the sink ledge.

Guarantee: Franke sinks are guaranteed for 25 years against manufacturing defect. Franke taps are guaranteed against defective materials and workmanship for 1 year in relation to coatings and finishes, and 5 years in relation to moving parts. Franke will replace (and where appropriate repair) defective sinks. In relation to taps, Franke will where appropriate provide replacement parts for your taps or replace your taps. Any associated or ancillary costs to be incurred by you as a result of replacement of Franke sinks and taps under this guarantee shall in all cases be previously approved by Franke UK Limited.

This guarantee is in addition to and does not affect your statutory rights.