

Kubus Multibowl KBX 160 34-16 Specifications

- One and a half bowl undermounted configuration
- One cut-out required
- Semi-Integrated 90mm Waste at rear of bowl
- Attractive 25mm radius
- Hygienic flat overflow
- Easy to clean
- Minimalist design
- Available left hand or right hand small bowl

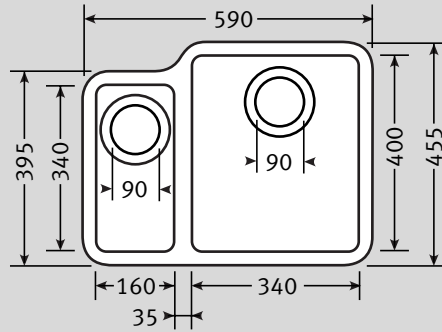

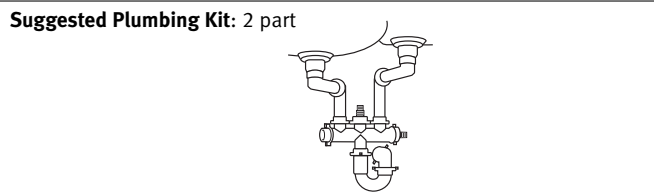
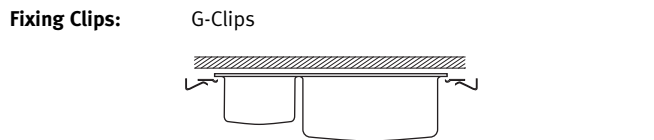
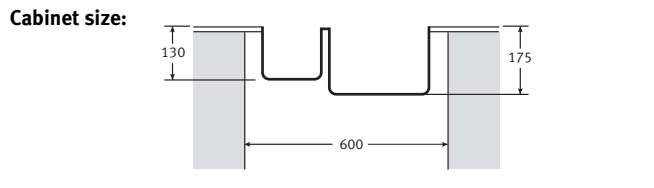

Material:	Stainless Steel
Application:	Undermount
Bowl size:	340 x 400 x 175 160 x 340 x 130
Drainer Format:	N/A
Cut-out size:	Utilise Template
Colour:	Silk Stainless Steel
Seal:	N/A
Insulation:	Black Pads for sound insulation
Heat Resistance:	Up to 300°C
Earthing Point:	N/A



Waste: 1 x Lira 90mm Semi-Integrated Basket Strainer Waste with overflow
1 x Lira 90mm Semi-Integrated Basket Strainer Waste

Overflow:

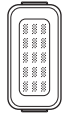
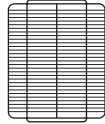
Accessories available:

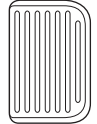
			
Strainer Bowl with handles Stainless Steel	Drainer Grille Stainless Steel	Food Preparation Platter Wood/Iroko	Kubus Food Preparation Platter/Bread Board Mahogany

Taps: Any Franke tap can be utilised with this model*.
*Ceramic disc taps in certain installations or where there is a low head of water (below 4 meters) may not provide adequate flow rates. You are advised to check with your supplier.

Guarantee: Franke sinks are guaranteed for 25 years against manufacturing defect. Franke taps are guaranteed against defective materials and workmanship for 1 year in relation to coatings and finishes, and 5 years in relation to moving parts. Franke will replace (and where appropriate repair) defective sinks. In relation to taps, Franke will where appropriate provide replacement parts for your taps or replace your taps. Any associated or ancillary costs to be incurred by you as a result of replacement of Franke sinks and taps under this guarantee shall in all cases be previously approved by Franke UK Limited. This guarantee is in addition to and does not affect your statutory rights.