

# Mythos MMX 661 Specifications

- Modern minimalist design
- 25mm radii
- Glide and Slide accessories included
- 2 x 90mm Basket Strainer Wastes. Capable of adaptation to take a Waste Disposal Unit.
- Ergonomic configuration
- Hygienic flat overflow
- Rollamat accessory available

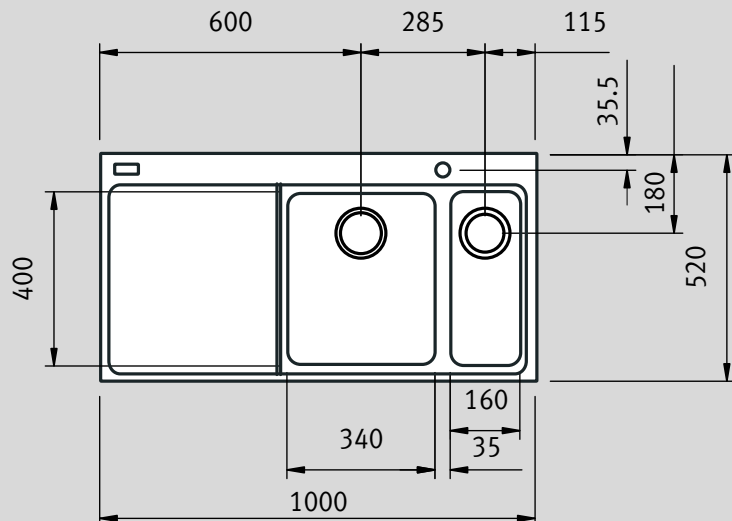

<b>Material:</b>	Stainless Steel
<b>Application:</b>	Inset
<b>Bowl size:</b>	340 x 400 x 192mm 160 x 400 x 130mm
<b>Drainer Format:</b>	Left or right hand drainer available
<b>Cut-out size:</b>	989 x 509mm
<b>Colour:</b>	Silk finish Stainless Steel
<b>Seal:</b>	Polyurethane seal
<b>Insulation:</b>	Grey Dynaphon for heat and sound
<b>Heat Resistance:</b>	Up to 300°C

**Waste:** 1 x Lira 90mm Semi-Integrated Basket Strainer Waste with overflow  
1 x Lira 90mm Semi-Integrated Basket Strainer Waste

**Overflow:**

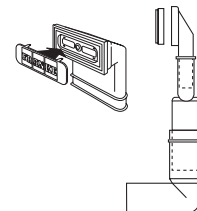
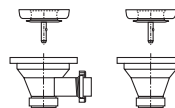

**Cabinet size:**

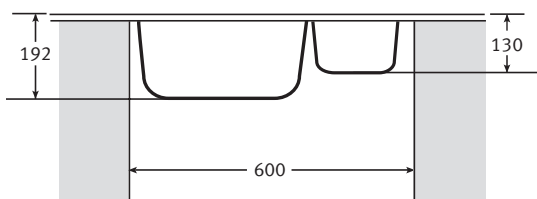

**Sink Profile:** Swiss Edge      **Fixing Clips:** 'S' rail

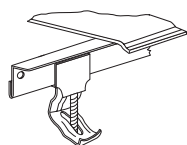
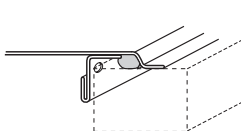

**Suggested Plumbing Kit:** 2 Part

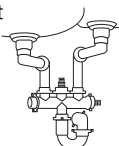

**Accessories available:**

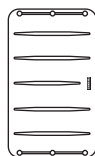

**Sliding Glass Chopping Board**

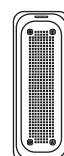

**Strainer Bowl Stainless Steel**

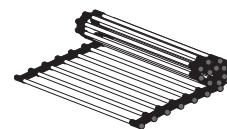

**Rollamat 40**

**Taps:** Any Franke tap can be utilised with this model\*.

\*Ceramic disc taps in certain installations or where there is a low head of water (below 4 metres) may not provide adequate flow rates. You are advised to check with your supplier. Some taps may need bracing to avoid flexing of the sink ledge.

**Guarantee:** Franke sinks are guaranteed for 25 years against manufacturing defect. Franke taps are guaranteed against defective materials and workmanship for 1 year in relation to coatings and finishes, and 5 years in relation to moving parts. Franke will replace (and where appropriate repair) defective sinks. In relation to taps, Franke will where appropriate provide replacement parts for your taps or replace your taps. Any associated or ancillary costs to be incurred by you as a result of replacement of Franke sinks and taps under this guarantee shall in all cases be previously approved by Franke UK Limited.

This guarantee is in addition to and does not affect your statutory rights.