

# Planar PPX 611 Specifications

- **Minimalist design**
- **Pop-up waste**
- **Single bowl format**
- **Plain drainer**
- **90mm Waste** Capable of adaptation to take a food waste disposal unit

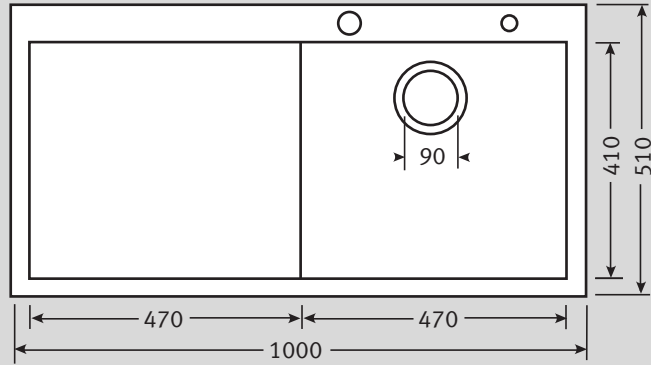

<b>Material:</b>	Stainless Steel
<b>Application:</b>	Inset
<b>Bowl size:</b>	470 x 410 x 195
<b>Drainer Format:</b>	Left or Right hand available
<b>Cut-out size:</b>	984 x 494 cr=20
<b>Colour:</b>	Silk
<b>Seal:</b>	Apply sealant locally
<b>Insulation:</b>	Black pads for sound
<b>Heat Resistance:</b>	Up to 300°C
<b>Earthing Point:</b>	N/A

**Waste:** 1 x 90mm Basket Waste with overflow & Pop-up assembly

**Overflow:**

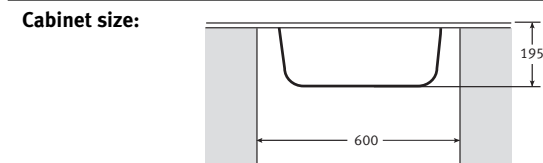
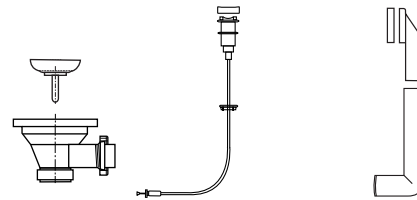

**Sink Profile:** Rounded

**Fixing Clips:**

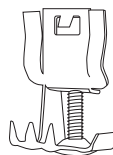
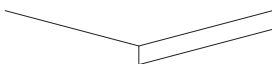

**Suggested Plumbing Kit:** 1 part

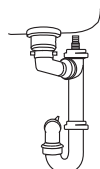

**Accessories available:**

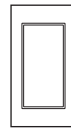

**Food Preparation Platter Hygenia**

**Taps:** Any Franke tap can be utilised with this model\*.

\*Ceramic disc taps in certain installations or where there is a low head of water (below 4 metres) may not provide adequate flow rates. You are advised to check with your supplier.

Some taps may need bracing to avoid flexing of the sink ledge.

**Guarantee:** Franke sinks are guaranteed for 25 years against manufacturing defect. Franke taps are guaranteed against defective materials and workmanship for 1 year in relation to coatings and finishes, and 5 years in relation to moving parts. Franke will replace (and where appropriate repair) defective sinks. In relation to taps, Franke will where appropriate provide replacement parts for your taps or replace your taps. Any associated or ancillary costs to be incurred by you as a result of replacement of Franke sinks and taps under this guarantee shall in all cases be previously approved by Franke UK Limited. This guarantee is in addition to and does not affect your statutory rights.