

Compact CPX 110 34 Specifications

- **1 x 90mm Waste with Basket Strainer Waste.** Capable of adaptation to take Waste Disposal Unit
- **3 colours of bespoke accessories available**
- **Compact bowl design**
- **Available as part of a Designer Pack**

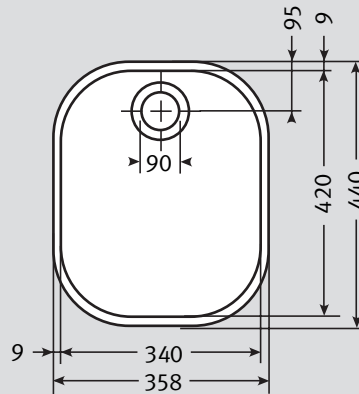

Material:	Stainless Steel
Application:	Undermounted
Bowl Size:	340 x 420 x 175
Drainer Format:	N/A
Cut-out Size:	Utilise template
Colour:	Silk Stainless Steel
Seal:	Apply sealant locally
Insulation:	Grey Dynaphon for heat and sound
Heat Resistance:	Up to 300°C
Earthing Point:	Supplied with sink

Cabinet Size:

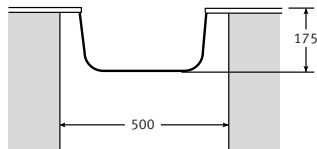

Fixing Clips: Provided

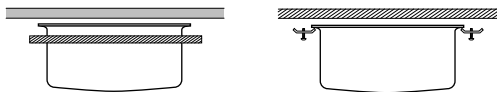

Alternative fixing systems

Suggested Plumbing Kit: 1 part

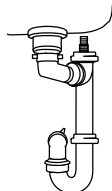

Waste: 1 x Lira 90mm Basket Strainer Waste with overflow

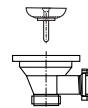

Overflow:



Accessories Available:

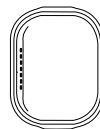

Drainer Tray
Available in White, Almond, Brown or Black

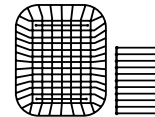

Drainer Basket/ Plate Rack
Available in White, Almond, Brown or Black

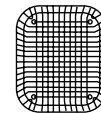

Drainer Basket
Stainless Steel



Food Preparation Platter
Iroko



Food Preparation Platter
Hygenia

N.B. Cut out may not allow for accessories

Taps: Any Franke tap can be utilised with this model*.

*Ceramic disc taps in certain installations or where there is a low head of water (below 4 metres) may not provide adequate flow rates. You are advised to check with your supplier.

Guarantee: Franke sinks are guaranteed for 25 years against manufacturing defect. Franke taps are guaranteed against defective materials and workmanship for 1 year in relation to coatings and finishes, and 5 years in relation to moving parts. Franke will replace (and where appropriate repair) defective sinks. In relation to taps, Franke will where appropriate provide replacement parts for your taps or replace your taps. Any associated or ancillary costs to be incurred by you as a result of replacement of Franke sinks and taps under this guarantee shall in all cases be previously approved by Franke UK Limited. This guarantee is in addition to and does not affect your statutory rights.