

Compact CPX 670 Specifications

- **Unique Double-Edge profile and corner radii.**
Sink lies completely flat on worktop and cloths will not snag on corners
- **Two and a half bowl configuration**
- **3 x 90mm Waste with Basket Strainer Waste.** Capable of adaptation to take Waste Disposal Unit
- **3 colours of bespoke accessories available**
- **Classic Compact Franke design**

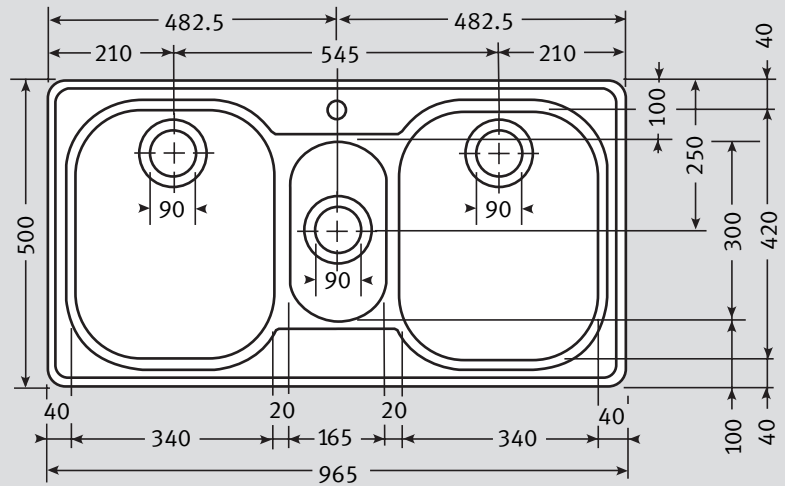
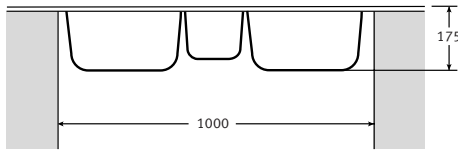

Material:	Stainless Steel
Application:	Inset or undermount
Bowl size:	340 x 420 x 175 (x2) 165 x 300 x 130 } Bowls welded to frame
Drainer Format:	Not applicable
Cut-out size:	949 x 484 (cr=20)
Colour:	Silk Stainless Steel
Seal:	Factory Fitted Polyurethane Seal
Insulation:	Grey Dynaphon for heat and sound
Heat Resistance:	Up to 300°C
Earthing Point:	Located at end of clip rail
Cabinet size:	

Sink Profile: Double Edge

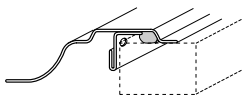

Fixing Clips: 'S' rail

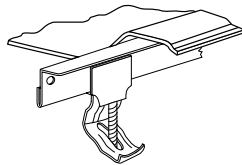

Suggested Plumbing Kit: 3 part

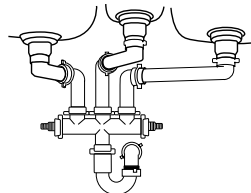

Waste: 1 x Lira 90mm Basket Strainer Waste with overflow
2 x Lira 90mm Basket Strainer Waste

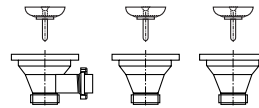

Overflow:

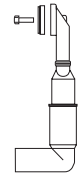

Accessories available:

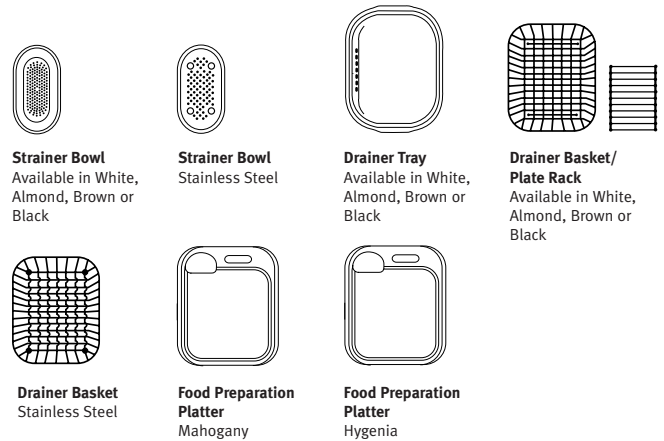

Taps: Any Franke tap can be utilised with this model*.

*Ceramic disc taps in certain installations or where there is a low head of water (below 4 metres) may not provide adequate flow rates. You are advised to check with your supplier.

Some taps may need bracing to avoid flexing of the sink ledge.

Guarantee: Franke sinks are guaranteed for 25 years against manufacturing defect. Franke taps are guaranteed against defective materials and workmanship for 1 year in relation to coatings and finishes, and 5 years in relation to moving parts. Franke will replace (and where appropriate repair) defective sinks. In relation to taps, Franke will where appropriate provide replacement parts for your taps or replace your taps. Any associated or ancillary costs to be incurred by you as a result of replacement of Franke sinks and taps under this guarantee shall in all cases be previously approved by Franke UK Limited.

This guarantee is in addition to and does not affect your statutory rights.