

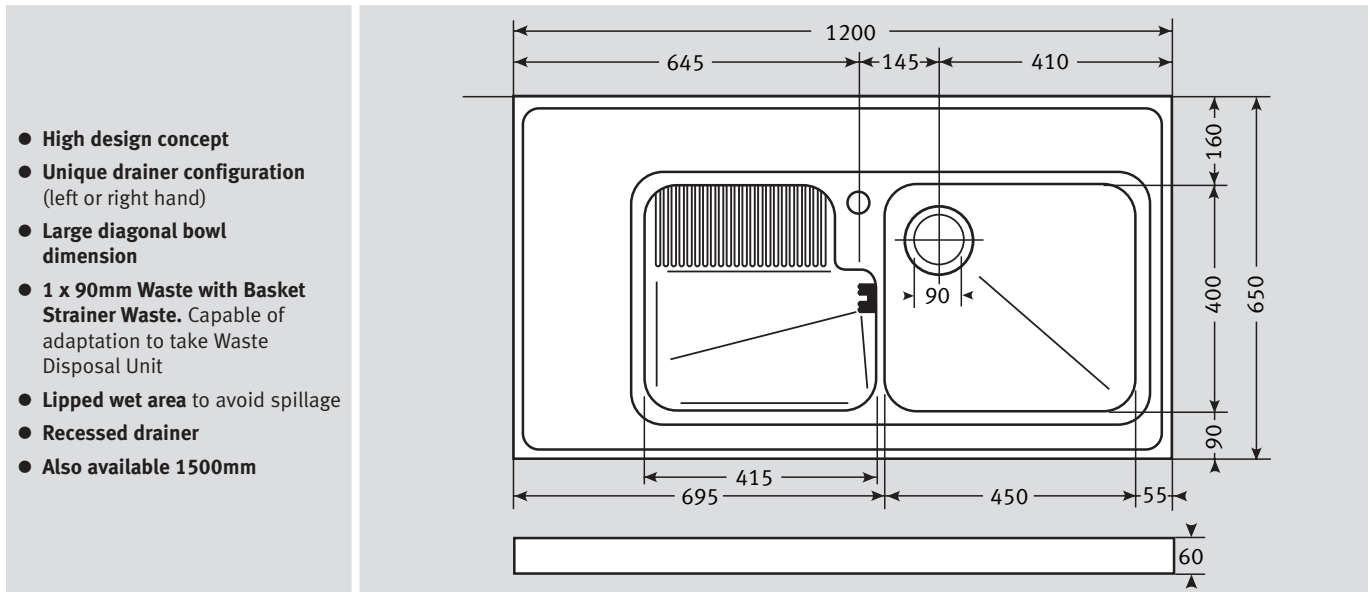

Range EPX 714 Handed (1200) Specifications

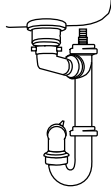
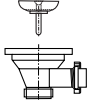
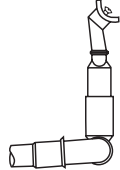
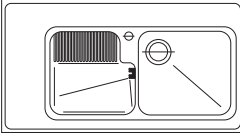
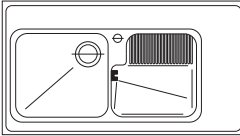
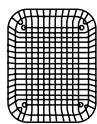

- High design concept
- Unique drainer configuration (left or right hand)
- Large diagonal bowl dimension
- 1 x 90mm Waste with Basket Strainer Waste. Capable of adaptation to take Waste Disposal Unit
- Lipped wet area to avoid spillage
- Recessed drainer
- Also available 1500mm

Material:	Stainless Steel	Suggested Plumbing Kit: 1 part	
Application:	Specialised stand alone unit	Waste: 1 x Lira 90mm Basket Strainer Waste with overflow	
Bowl size:	450 x 400 x 180	Overflow:	
Drainer Format:	<p>Left hand drainer</p>  <p>Right hand drainer</p> 	Accessories available:	   <p>Drainer Basket Stainless Steel</p> <p>Drainer Grille Stainless Steel</p> <p>Food Preparation Platter Iroko</p>
Cut-out size:	N/A		
Colour:	Silk Stainless Steel		
Seal:	N/A		
Insulation:	Grey Dynaphon for heat and sound and water resistant chipboard V100 E1 backing		
Heat Resistance:	Up to 300°C		
Earthing Point:	Utilise frame		
Cabinet size:	Bespoke to size of unit (min 600 base)		
			
Fixing Clips:	Not applicable	Taps: Any Franke tap can be utilised with this model*.	

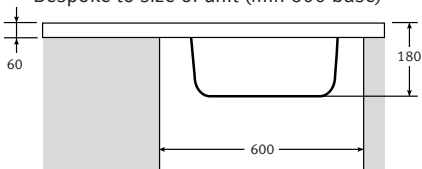
*Ceramic disc taps in certain installations or where there is a low head of water (below 4 metres) may not provide adequate flow rates. You are advised to check with your supplier.

Guarantee: Franke sinks are guaranteed for 25 years against manufacturing defect. Franke taps are guaranteed against defective materials and workmanship for 1 year in relation to coatings and finishes, and 5 years in relation to moving parts. Franke will replace (and where appropriate repair) defective sinks. In relation to taps, Franke will where appropriate provide replacement parts for your taps or replace your taps. Any associated or ancillary costs to be incurred by you as a result of replacement of Franke sinks and taps under this guarantee shall in all cases be previously approved by Franke UK Limited. This guarantee is in addition to and does not affect your statutory rights.

The Franke policy is one of continued improvement, and Franke reserve the right to alter models and specifications without notice.