

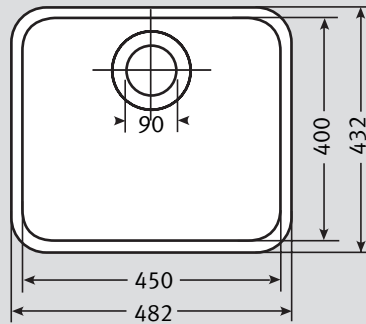

# Galassia GAX 110 45 Specifications

- **1 x 90mm Waste with Basket Strainer Waste.** Capable of adaptation to take Waste Disposal Unit
- **Infinito bowl design**
- **Available as a Designer Pack**

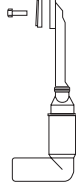
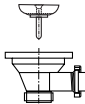
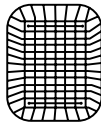

<b>Material:</b>	Stainless Steel	<b>Waste:</b>	1 x Lira 90mm Basket Strainer Waste with overflow	<b>Overflow:</b>	
<b>Application:</b>	Undermounted				
<b>Bowl Size:</b>	450 x 400 x 190				
<b>Drainer Format:</b>	N/A				
<b>Cut-out Size:</b>	Utilise template				
<b>Colour:</b>	Silk Stainless Steel	<b>Accessories Available:</b>			
<b>Seal:</b>	Apply sealant locally	<b>Drainer Basket</b> Available in White, Almond or Brown		<b>Food Preparation Platter</b> Mahogany	
<b>Insulation:</b>	Factory fitted black pad				
<b>Heat Resistance:</b>	Up to 300°C				
<b>Earthing Point:</b>	Supplied with sink				
<b>Cabinet Size:</b>					
<b>Fixing Clips:</b>	Provided				
	Alternative fixing systems				
<b>Suggested Plumbing Kit:</b>	1 part				
			<b>N.B.</b> Cut out may not allow for accessories		
			<b>Taps:</b> Any Franke tap can be utilised with this model*.		
			*Ceramic disc taps in certain installations or where there is a low head of water (below 4 metres) may not provide adequate flow rates. You are advised to check with your supplier.		

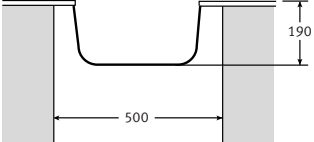
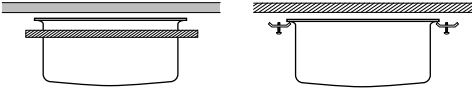
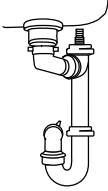
**Guarantee:** Franke sinks are guaranteed for 25 years against manufacturing defect. Franke taps are guaranteed against defective materials and workmanship for 1 year in relation to coatings and finishes, and 5 years in relation to moving parts. Franke will replace (and where appropriate repair) defective sinks. In relation to taps, Franke will where appropriate provide replacement parts for your taps or replace your taps. Any associated or ancillary costs to be incurred by you as a result of replacement of Franke sinks and taps under this guarantee shall in all cases be previously approved by Franke UK Limited. This guarantee is in addition to and does not affect your statutory rights.