

# Infinito INX 621-S Specifications

- Modern functional design
- 2 extra large multi-purpose bowls
- 2 x 90mm Wastes with Basket Strainer Waste. Capable of adaptation to take Waste Disposal Unit
- Wastes at rear of bowls
- 3 colours of bespoke accessories available

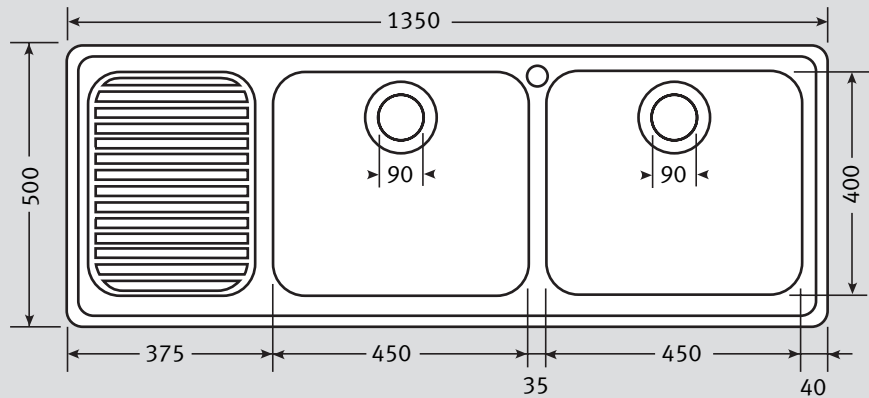

<b>Material:</b>	Stainless Steel
<b>Application:</b>	Inset
<b>Bowl size:</b>	450 x 400 x 190 (x2) (Bowls welded to frame)
<b>Drainer Format:</b>	Left or right hand drainer available
<b>Cut-out size:</b>	1330 x 480 (cr=20)
<b>Colour:</b>	Silk Stainless Steel
<b>Seal:</b>	Sealing strip supplied
<b>Insulation:</b>	Factory fitted black pads
<b>Heat Resistance:</b>	Up to 300°C
<b>Earthing Point:</b>	Utilise clip rail slots

**Waste:** 1 x Lira 90mm Basket Strainer Waste with overflow  
1 x Lira 90mm Basket Strainer Waste

**Overflow:**

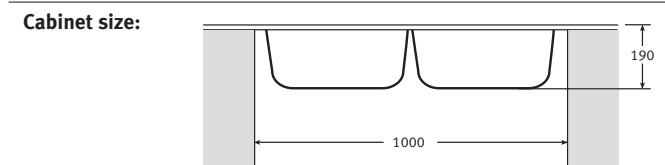
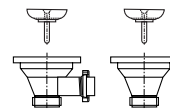

**Accessories available:**

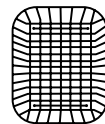

**Drainer Basket**  
Available in White, Almond or Brown



**Food Preparation Platter**  
Mahogany

**NB.** Model will not accommodate taps with a base diameter of over 50mm

**Sink Profile:** Folded edge

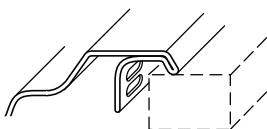

**Fixing Clips:**

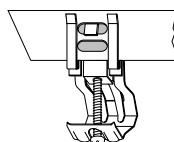

**Suggested Plumbing Kit:** 2 part

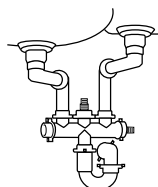

**Taps:** Any Franke tap can be utilised with this model\* (Owing to the profile, this model will not accommodate taps with a base diameter of over 50mm).

\*Ceramic disc taps in certain installations or where there is a low head of water (below 4 metres) may not provide adequate flow rates. You are advised to check with your supplier.

Some taps may need bracing to avoid flexing of the sink ledge.

**Guarantee:** Franke sinks are guaranteed for 25 years against manufacturing defect. Franke taps are guaranteed against defective materials and workmanship for 1 year in relation to coatings and finishes, and 5 years in relation to moving parts. Franke will replace (and where appropriate repair) defective sinks. In relation to taps, Franke will where appropriate provide replacement parts for your taps or replace your taps. Any associated or ancillary costs to be incurred by you as a result of replacement of Franke sinks and taps under this guarantee shall in all cases be previously approved by Franke UK Limited.

This guarantee is in addition to and does not affect your statutory rights.