

Mythos MTX 651 Specifications

- Modern minimalist design
- 25mm radii
- Jumbo bowls
- Glide and Slide accessories included
- 2 x 90mm Basket Strainer Wastes. Capable of adaptation to take a Waste Disposal Unit.

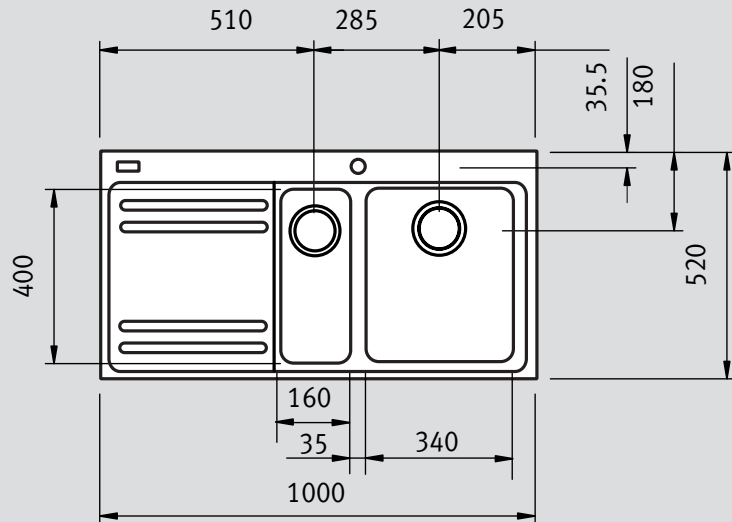

Material:	Stainless Steel
Application:	Inset
Bowl size:	340 x 400 x 192mm 160 x 400 x 130mm
Drainer Format:	Left or right hand drainer available
Cut-out size:	989 x 509mm
Colour:	Silk Stainless Steel
Seal:	Polyurethane seal
Insulation:	Grey Dynaphon for heat and sound
Heat Resistance:	Up to 300°C
Earthing Point:	N/A

Waste: 1 x Lira 90mm Basket Strainer Waste with overflow
1 x Lira 90mm Basket Strainer Waste

Overflow:

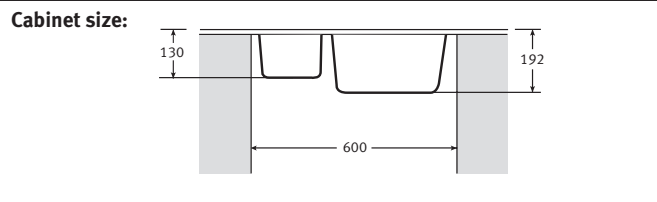
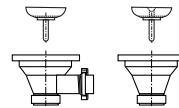

Sink Profile: Swiss Edge **Fixing Clips:** 'S' rail

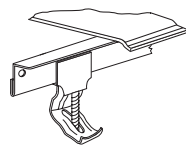
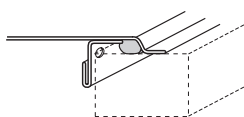

Suggested Plumbing Kit: 2 Part

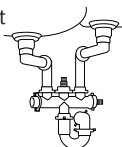

Accessories available:

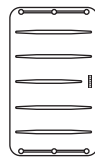

Sliding Glass Chopping Board

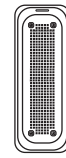

Strainer Bowl Stainless Steel

Taps: Any Franke tap can be utilised with this model*.

*Ceramic disc taps in certain installations or where there is a low head of water (below 4 metres) may not provide adequate flow rates. You are advised to check with your supplier. Some taps may need bracing to avoid flexing of the sink ledge.

Guarantee: Franke sinks are guaranteed for 25 years against manufacturing defect. Franke taps are guaranteed against defective materials and workmanship for 1 year in relation to coatings and finishes, and 5 years in relation to moving parts. Franke will replace (and where appropriate repair) defective sinks. In relation to taps, Franke will where appropriate provide replacement parts for your taps or replace your taps. Any associated or ancillary costs to be incurred by you as a result of replacement of Franke sinks and taps under this guarantee shall in all cases be previously approved by Franke UK Limited.

This guarantee is in addition to and does not affect your statutory rights.